

PARTS LIST			
ITEM	QTY	PART NUMBER	DESCRIPTION
1	1	M6219050	Front Panel
7	2	S620255X	Side Panel
2	1	M620105X	Rear Panel
3	2	M620050X	Handle
4	14	M3x8 CSK Screw	Assembly Screws
5	4	M4x16 CSK Screw	Front Panel Screws
6	6	M3x8 Pan Screw	Rear Panel Screws
8	1	M6203079	Top Panel
9	1	M6203059	Base Panel

**NOTES.**  
 Case metalwork is made from 1.5 mm aluminium and painted RAL 9005 fine texture black.  
 Front panel is made from 3 mm aluminium with a clear etch & anodise finish.  
 Handles are made from an aluminium extrusion & also painted RAL 9005 fine texture black.  
 All parts are fitted with M4 studs for earth use.

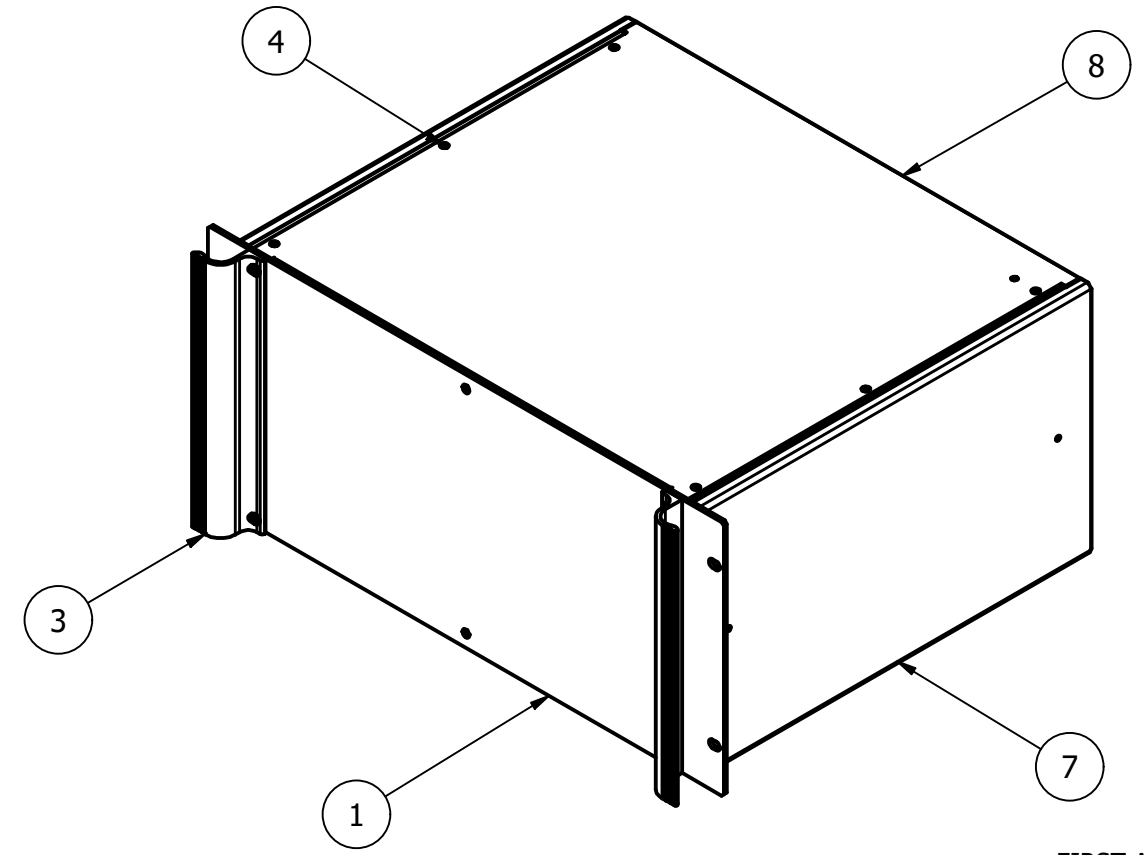

FIRST ANGLE PROJECTION

Designed by L Clark	Description Combimet 5U x 19" x 365 mm Unvented	Date 03/02/2022	Scale 1:5
<b>METCASE ENCLOSURES</b> 15 Brunel Way, Segensworth East, Fareham, Hampshire, PO15 5TX, UK. Tel: +44 (0)1489 583858 Email: sales@metcase.co.uk		<b>METcase™</b> www.metcase.com Part Number <b>M6219559</b>	
		Issue 2	Sheet 1 / 1

© OKW Enclosures Ltd (Date as shown). This drawing contains proprietary information of OKW Enclosures Ltd and is tendered subject to the following conditions. The information be retained in confidence, not be reproduced or copied, and not be used or incorporated in any product, unless permission is obtained in writing from OKW Enclosures Ltd.