

Minimet



Minimet Instrument Cases

Modern instrument cases, in eight compact sizes, for desktop and portable applications. Folded aluminium top and base panels are assembled by hidden fixing screws on the underside. Front and rear panel apertures are recessed by 8mm and 14mm at the opposite ends. Front and rear panels are ordered separately.

Minimet Instrumenten-Gehäuse

Moderne Instrumentengehäuse in acht kompakten Größen für Desktop- und portable Anwendungen. Die gefalteten Oberteile und Bodenplatten aus Aluminium werden unsichtbar von der Gehäuseunterseite montiert. Der Front- und Rückplattenbereich ist um 8 bzw. 14 mm zurückversetzt. Front- und Rückplatten als Zubehör erhältlich.

Boîtiers d'instruments Minimet

Boîtiers d'instruments modernes, en huit formats compacts, pour les applications de table et portables. Les panneaux supérieures et inférieures en aluminium plié sont assemblés au moyen de vis de fixation cachées en sous-face. Les ouvertures des panneaux avant et arrière sont encastrées de 8 mm et 14 mm sur les faces opposées. Panneaux avant et arrière à commander séparément.

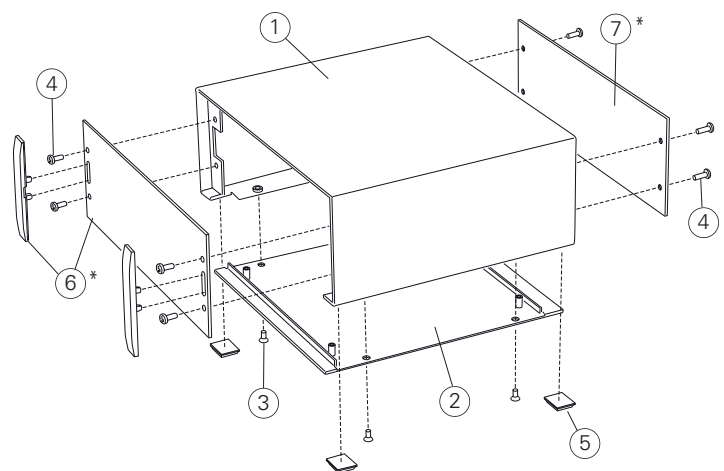

Supply

- ① Top cover
- ② Base panel
- ③ M3 x 6 mm (x4/6)
- ④ M3 x 8 mm (x8)
- ⑤ Rubber foot (x4)
- ⑥ * Front/rear panel kit AN
- ⑦ * Front/rear panel PN

* Accessories

Lieferumfang

- Deckplatte
- Bodenplatte
- M3 x 6 mm (x4/6)
- M3 x 8 mm (x8)
- Gummifuß (x4)
- * Front-/ Rückplatten-Set AN
- * Front-/ Rückplatte PN

* Zubehör

Fourniture

- Couvercle supérieur
- Plaque inférieure
- M3 x 6 mm (x4/6)
- M3 x 8 mm (x8)
- Pied du boîtier (x4)
- * Kit de plaque avant/arrière AN
- * Kit de plaque avant/arrière PN

* Accessoires

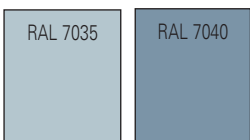

Standard colours
Standardfarben
Coloris standard

Minimet

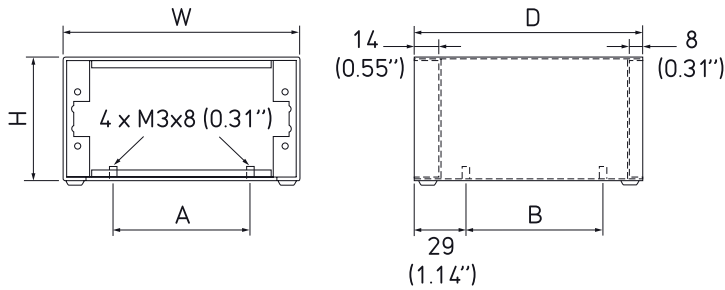

Part No. Bestell-Nr./Réf.	Version	W	D	H	A	B
M 51 13 115	1	134.5 (5.29")	130 (5.11")	38.5 (1.51")	72.5 (2.85")	78 (3.07")
M 51 13 125	2	134.5 (5.29")	130 (5.11")	70.0 (2.75")	72.5 (2.85")	78 (3.07")
M 51 13 215	3	134.5 (5.29")	200 (7.87")	38.5 (1.51")	72.5 (2.85")	148 (5.82")
M 51 13 225	4	134.5 (5.29")	200 (7.87")	70.0 (2.75")	72.5 (2.85")	148 (5.82")
M 51 17 115	5	174.5 (6.87")	160 (6.29")	38.5 (1.51")	111.5 (4.38")	108 (4.25")
M 51 17 125	6	174.5 (6.87")	160 (6.29")	70.0 (2.75")	111.5 (4.38")	108 (4.25")
M 51 17 215	7	174.5 (6.87")	240 (9.44")	38.5 (1.51")	111.5 (4.38")	188 (7.40")
M 51 17 225	8	174.5 (6.87")	240 (9.44")	70.0 (2.75")	111.5 (4.38")	188 (7.40")



Version 1



Version 2

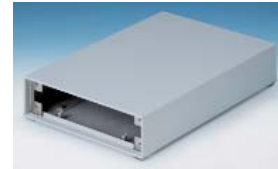

Version 3



Version 4

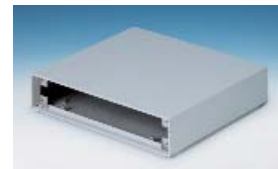

Version 5



Version 6

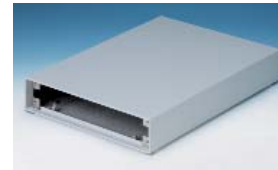

Version 7



Version 8

Front/Rear Panel Kit AN

Front-/Rückplatten-Set AN
Kit De Plaque Avant/Arrière AN

Supply: Panel (matt anodised aluminium)
2 clip-on ABS trims, RAL 7040

Lieferumfang: 1 Platte (Al, matt eloxiert)
2 aufrastbare ABS Blenden, RAL 7040

Fourniture: Plaque (aluminium anodise, mat)
2 garnitures encliquetables en ABS, RAL 7040

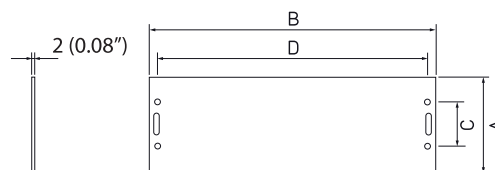

Part No. Bestell-Nr./Réf.	Version	A	B	C	D
M 51 00 510	1 & 3	33.6 (1.32")	129.5 (5.09")	22.1 (0.87")	118 (4.64")
M 51 00 520	2 & 4	65.1 (2.56")	129.5 (5.09")	30.8 (1.21")	118 (4.64")
M 51 00 550	5 & 7	33.6 (1.32")	169.5 (6.67")	22.1 (0.87")	158 (6.22")
M 51 00 560	6 & 8	65.1 (2.56")	169.5 (6.67")	30.8 (1.21")	158 (6.22")



Front/Rear Panel PN

Front-/Rückplatte PN
Plaque Avant/Arrière PN

Painted light grey, RAL 7035
Lackierung lichgrau, RAL 7035
Laqué en gris clair, RAL 7035

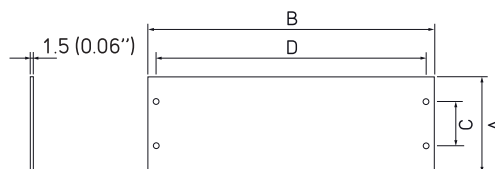

Part No. Bestell-Nr./Réf.	Version	A	B	C	D
M 51 00 515	1 & 3	33.6 (1.32")	129.5 (5.09")	22.1 (0.87")	118 (4.64")
M 51 00 525	2 & 4	65.1 (2.56")	129.5 (5.09")	30.8 (1.21")	118 (4.64")
M 51 00 555	5 & 7	33.6 (1.32")	169.5 (6.67")	22.1 (0.87")	158 (6.22")
M 51 00 565	6 & 8	65.1 (2.56")	169.5 (6.67")	30.8 (1.21")	158 (6.22")

